

# 3520 Series Leak Tester



## Product Specifications

### Purpose-built for the demands of manufacturing

The patented 3520 Series Leak Tester delivers industry-leading accuracy and fast cycle times. The result of years of dedicated research and development and customer testing, the 3520 Series is delivering spectacular results to manufacturers.



#### Accurate

- Pressure measurement resolution – down to  $\pm 0.000,01$  psi
- Pressure control resolution – down to  $\pm 0.000,01$  psi
- Flow measurement – down to  $\pm 0.2\%$  of full scale



#### Fast

- Ultra-fast fill
- Fast pressure stabilization
- Fast pass/fail decisions



#### Flexible

- Wide range of tests
- Test any part
- Configurable software



#### Easy

- Easy to use, maintain and service
- Self-test mode for automatic verification
- Simple calibration processes
- Easy access to the unit



#### Intelligent

- Web-based setup and diagnostics
- Ethernet interface
- Advanced Process Signature Verification (PSV) software
- Rich data output
- Remote control and operation



#### Use the 3520 Series for:

- Pressure decay
- Vacuum
- Flow
- Blockage
- Volume measurement
- Burst testing
- Helium evacuate and fill
- Customizable pressure and flow sequencing

# Key Features

## Designed to provide superfine accuracy

- Highly optimized manifold design
- Separation of controller and pneumatics enable placement of system close to the device under test, reducing hose length and minimizing other factors that affect accuracy
- High quality sensors, including a MEMS digital flow meter for 5x better accuracy
- Precision measurement electronics, featuring three high speed processors, quad 24-bit A/D converters and sub micro volt level PCB design and layout
- $\mu$ PSI pressure regulation with advanced electronic dual stage proportional valves

## Temperature compensation that works

Available as an option to compensate for environmental factors, seasonal temperature fluctuations or hot/cold parts and washing.

- Two channels for part and ambient temperature sensing with a resolution of 0.0001°C
- Uses high accuracy, low noise resistance temperature detector (RTD) sensors

## Ultra-fast fill and stabilization

The 3520 Series incorporates innovations to deliver fast cycle times without sacrificing accuracy.

- Dual high speed electronic servo regulator design
  - High flow fast fill up to 300 slpm with ½" diameter ports and valves to move air quickly
  - Second stage high precision regulator and orifice for superb pressure and flow accuracy

## Proven signature analysis software

The 3520 Series uses Sciometric's PSV software, either on a sigPOD or on an industrial computer, to control the module.

- Advanced algorithms provide the industry's best defect detection
- Flexible configuration accommodates any test algorithm
- Proactively manage production by reviewing thousands of records directly on the test stand, using built-in control charts, histograms and other SPC tools

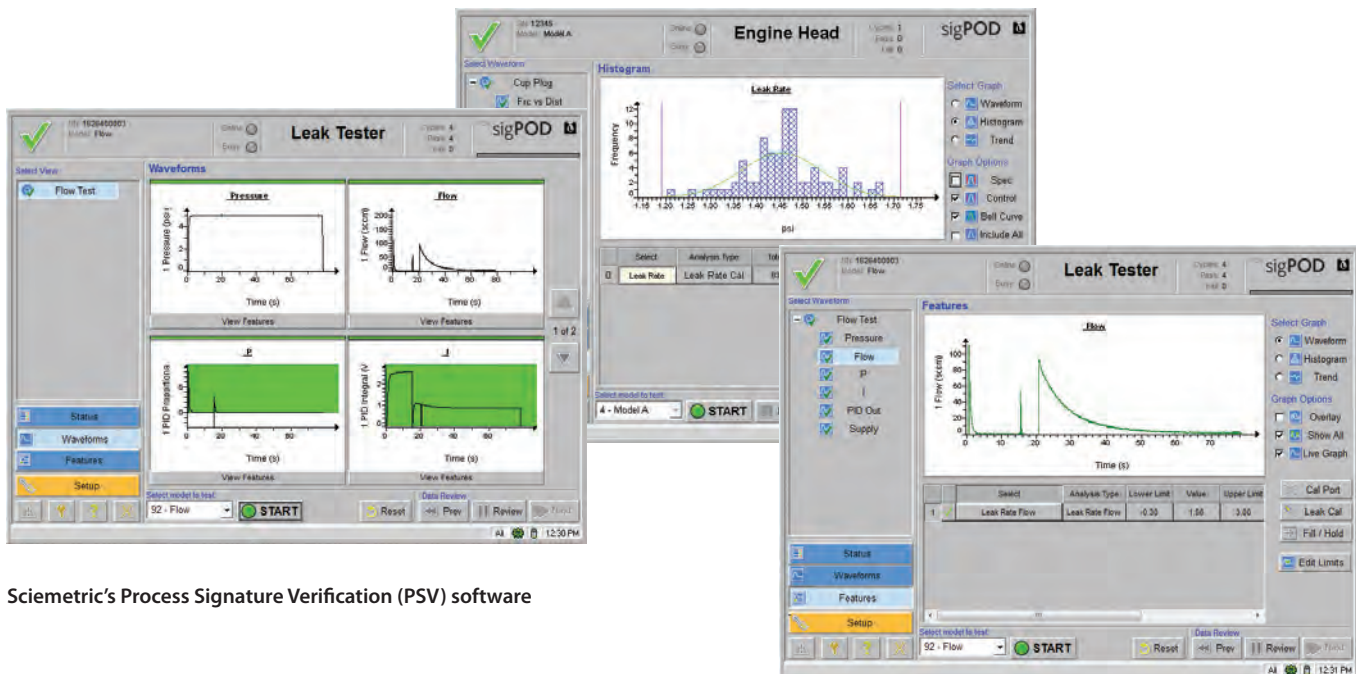

Sciometric's Process Signature Verification (PSV) software

## Web-based setup and diagnostics

Each 3520 Series module can be accessed remotely via any device with a web browser to view or manage:

- IP settings
- Information such as versions, CPU usage, memory usage, live readings including diagnostics (supply pressure, pilot pressure, supply voltage, etc.)
- Configuration: software profile (IP, name, units)

## Tuning Assistant for ease of setup

The software includes a tuning assistant feature that allows complete tuning of the leak test for optimized test results including fill and test times and PID valve control.

## Self-test mode for automatic verification

The unit under test (UUT) isolate valve allows complete self-test without any external connection changes.

- All aspects of the leak circuit are checked
- Self-test has access to external calibration port for cross-check
- Issues can be identified and pinpointed to the component level

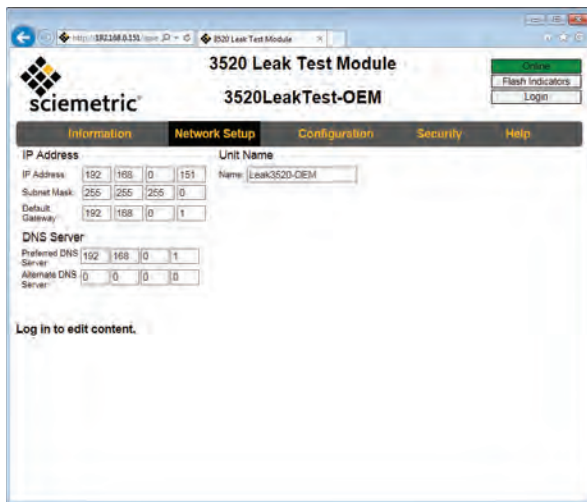

Web-based setup

## Simple calibration processes

The 3520 Series software and pneumatics support a very simple process to fully calibrate the system:

1. Pressure
2. Flow
3. Part volume (for pressure decay)

## Easy to maintain

The module is designed to be accessible to simplify maintenance.

- Four hex screws to access the inside of the unit
- All parts come out as a single unit
- Valve cartridges are replaceable

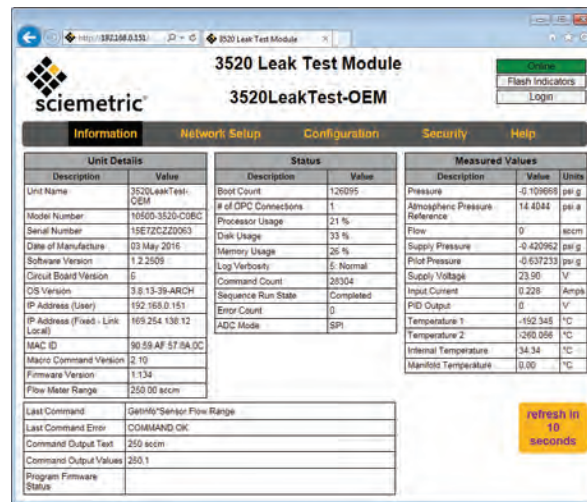

# Technical Specifications

## GENERAL

- Dimensions (HxWxD): 117.8 x 264 x 210 mm (7" x 10.4" x 8.25")
- Operating temperature: 5 – 40°C
- Operating humidity: 8 – 90 %
- Elevation: ≤2000 m
- Finish: powder-coated aluminum
- Environmental: IP65, Pollution Degree: 2
- Mounting options: Integrated wall mount brackets
- Vibration mounts: Included and required for operation
- Weight: 10.2 kg (22.5 lbs.)
- Approvals: CE, cNEMKOus

## ELECTRICAL

### Input power

- Connector: M12 4 pin T-code plug
- Supply: 24 V (22 to 26 VDC)
- Ripple: <250 mV peak to peak
- Power (Max): 40 W (including all accessories)
- Power (Typ): 10 W (single channel leak test)
- Power (Idle): 6 W
- Inrush current: 5 A for 0.25 s

### Ethernet

- Connector: M12 4 pin D-code socket
- Data rate: 100/10 Mbps

### External valve interface

- Connector: M12 8 pin A-code socket
- Valves: (4x) 2.5 W at 24 V

### Temperature input (x2)

- Connector: M12 4 pin A-code socket
- Sensor: 100 Ω Platinum RTD
- Excitation: 1.25 mA
- Range: 0 °C to 200 °C
- Noise: <0.001 °C rms
- Bandwidth: 10 Hz

## PNEUMATIC

### Leak test system

- Number of test channels per 3520: 1
- Valve Life Rating: 10,000,000 cycles (high flow manifold); 100,000,000 (low volume manifold)
- System Leak: <0.02 SCCM at 10 psig
- Fill rate (max): 300 SLPM (high flow manifold); 20 SLPM (low volume manifold)

### Air supply preparation for supply and pilot

- Standard: ISO 8573.1:2001 Class 1.4.2 or better
- Pre-filter: ≤ 5 μm
- Air Dryness: ≤ 3 °C Dew Point
- Oil Concentration: ≤ 0.1 mg/m<sup>3</sup>
- Gas compatibility: Air, Helium (consult factory for compatibility with other gases)

### Supply pressure

- Maximum: 100 psig for positive pressure; 5-3 psi below desired test pressure for vacuum pressure
- Minimum: 5-20 psi above test pressure for positive pressure; 13.75 psiv (28" Hg) for vacuum pressure
- Required Flow Capacity: 1000 SLPM (35 SCFM) or higher at 100 psig
- Stability: ±0.1 psi
- Pre-Regulation: Precision input regulator with supply pressure effect < 0.1 psi per 100 psi input pressure change is required (see optional accessories list).

### Pilot pressure (high flow manifold only)

- Minimum: 30 psig or supply pressure, whichever is greater
- Maximum: 135 psig

### Test pressure sensor

- Range Selection: (see model chart)
- Accuracy: ±0.25 % of FS, best-fit straight line
- Temperature error band: ±1.0 % of FS from 4 °C to 60 °C
- Noise: < 10 ppm rms of FS (<0.001 % of FS) - 300 Hz bandwidth  
< 1 ppm rms of FS (<0.0001 % of FS) - 1 Hz bandwidth
- Resolution: 0.06 ppm of FS

### FLOW METER (flow models only)

- Range Selection: (see model chart)
- For Full Scale Ranges ≤ 3000 SCCM Accuracy at 25 °C:<sup>1</sup>
  - ±1 % of reading when value is > 10 % of FS
  - ±0.2 % of FS when value is < 10% of FSAccuracy over full temperature range:<sup>1</sup>
  - ±2 % of reading when value is > 10 % of FS
  - ±0.5 % of FS when value is < 10% of FSRepeatability:<sup>1</sup>
  - ±0.1 % of reading when value is > 10 % of FS
  - ±0.1 % of FS when value is < 10% of FSPressure coefficient: ±0.014 % of reading/psi  
Response time: 4 ms (0.004 s)

## General Features

- Valve-operated calibration port
- Supply pressure sensor
- Pilot pressure sensor
- Internal variable flow self-test orifice
- UUT isolation valve
- Internal temperature sensor
- Diagnostic waveforms (supply voltage, supply current, control P, I, D and output values, PID response time)
- Fully adjustable control loop settings for electronic regulators
- Air piloted valves to reduce effects of heat in high flow manifold version
- Latching valves reduce effects of heat in low volume manifold version

Full scale of flow sensor is switchable with two ranges as follows:

- 10 SCCM and 50 SCCM
- 100 SCCM and 250 SCCM
- 1000 SCCM and 3000 SCCM

- For Full Scale Ranges ≥ 10 SLPM Accuracy: ±1.5 % of FS (15 to 25 °C)  
Repeatability: ±0.5 % of FS  
Temperature coefficient: <0.15 % of FS/°C  
Pressure coefficient: <±0.01 % of FS/psi  
Response time: 6 s for ±2 % of FS for readings of 25 to 100 % of FS
- Over range protection: Pressure is reduced to ensure no damage to flow meter
- Minimum Resolution: 0.02 %
- Bandwidth: 10 Hz

UUT= Unit under Test

FS= Full Scale

<sup>1</sup> 10 SCCM range values are 2x higher.

# System Diagram

A 3520 Series Leak Tester system uses a sigPOD or PC running Sciometric software (PSV, IPT or custom) as a controller. The controller can be placed in an optimal location for the operator and is connected via Ethernet to the 3520. It interfaces with the PLC, QualityWorX database (if applicable) and operator to download the control sequence to the 3520. The 3520 unit runs the sequence independently and sends the data collected to the controller. The controller then performs the analysis and final pass/fail decision. Up to four leak channels can be controlled with one sigPOD or instance of PSV software; higher channel counts are available with IPT Suite or custom software.

The figure below shows a typical installation including air preparation, precision pre-regulator for supply and pilot pressure, Ethernet connection between the controller (sigPOD) and the 3520 unit, 24 VDC power connection, UUT connection, external calibration orifice, as well as optional part and ambient temperature sensors.

Configurations showing the use of optional external multiplexer valves connected to the UUT port of the 3520 Series to test up to four chambers, parts or test configurations can be found in the product user guide. The external multiplexer valves can also be connected to the supply port of the 3520 unit to multiplex in different supply sources such as shop air, vacuum and helium. This allows the 3520 to perform evacuation and fill procedures automatically, with test zones at each stage.

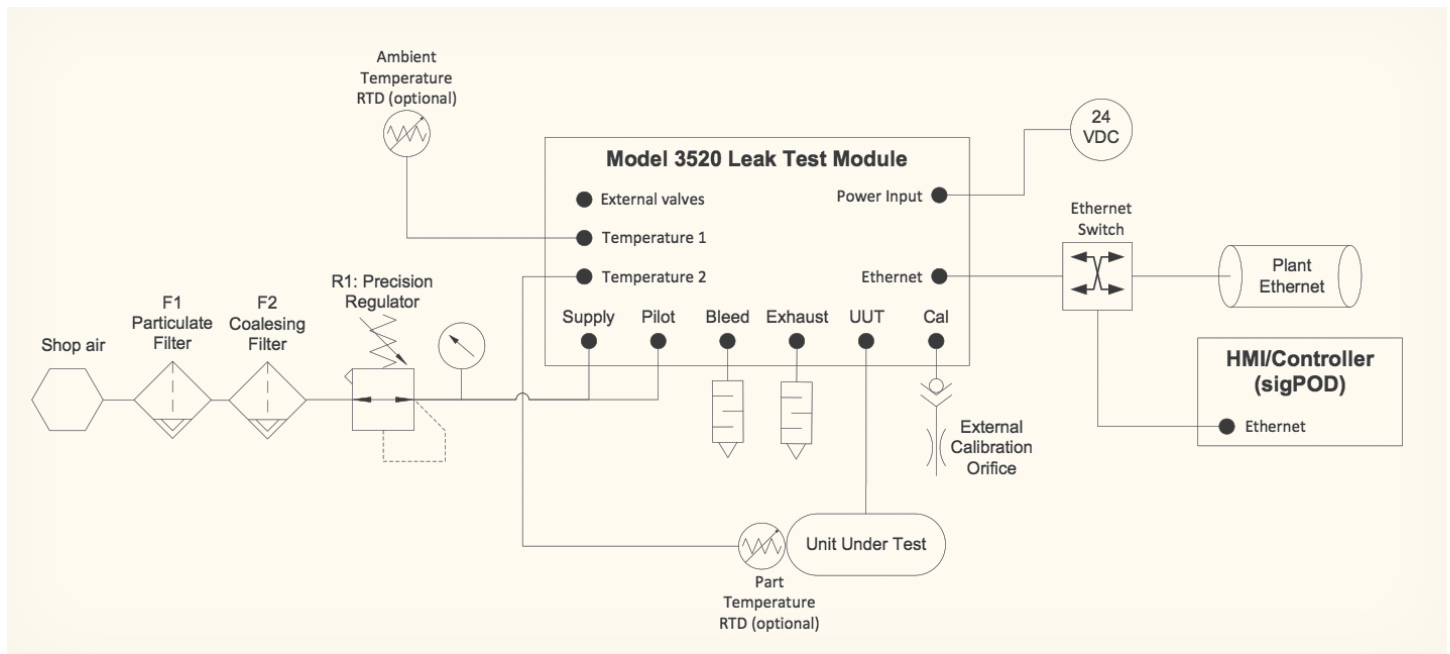

A typical 3520 Series installation

# Pneumatic Connections

Port	Low volume connection	High volume connection	Notes
<b>Supply</b>	¼ NPT	½ NPT	Supply air source.
<b>Pilot</b>	N/A	¼ NPT	Pilot pressure source for air-piloted valves.
<b>Bleed<sup>2</sup></b>	¼ NPT	¼ NPT	This port allows internal bleed, pilot and self-test gas flows to exhaust out.
<b>Exhaust<sup>2</sup></b>	¼ NPT	½ NPT	Test gas that is in the Unit Under Test is exhausted out of this port.
<b>Unit Under Test (UUT)</b>	¼ NPT	½ NPT	This is for connection to the Unit Under Test.
<b>Calibration</b>	¼ NPT	¼ NPT	This port is for calibration orifice connection. Quick-connect fittings such as the Swagelok QC4 and Staubli RBE 03 are recommended and available as optional accessories. If the calibration port is not going to be used, a plug or silencer should be installed.

<sup>2</sup> Resin silencers for the Bleed and Exhaust ports are shipped with the module.

# Mounting Information

The 3520 Series unit has rear integral brackets for mounting. Dimensions are in inches [mm].

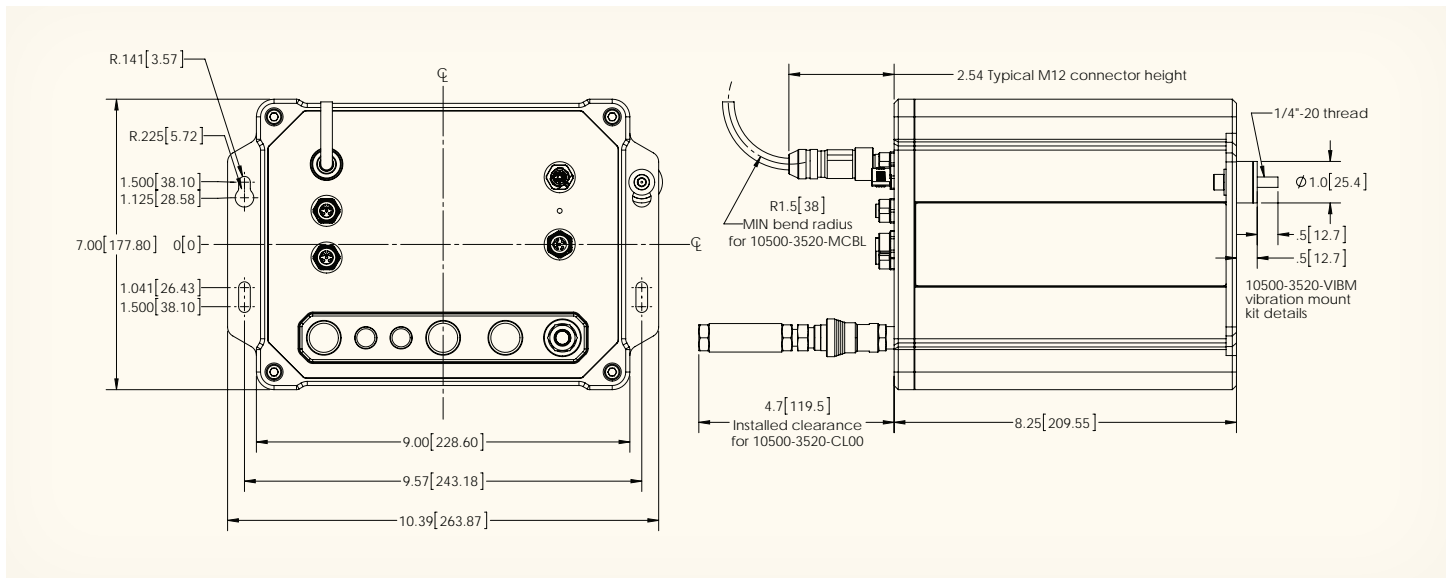

# Controller Options



	sigPOD 1202/1204	Software download
Leak channels supported per controller	4	4
On-board storage for 10,000+ complete records, including waveforms	✓	✓
Flexible PSV configurable test software	✓	✓
Support for custom software applications	✓	✓
IP52 rated enclosure suitable for industrial environments	✓	
Full color touchscreen display (optional)	10.4" Integrated	

## Ordering Information

Example: 10500-3520-D0AC

3520 Series Leak Tester Module optimized for large part volumes, 0 to 30 psig absolute pressure transducer, 10/50 SCCM mass flow meter range, dual precision electronic regulators, 2 temperature inputs and 4 digital outputs. Includes: power and Ethernet connectors and vibration mounts.







*Leak Master must be specified upon ordering.*

	Pressure range		Flow meter range	Fill configuration
<b>10500-3520-</b>	<b>Y</b>	<b>0</b>	<b>Y</b>	<b>Y</b>
	A – 0 to 5 psig	0	0 – no flow meter	B – Low volume manifold (20 SLPM fill rate)
	B – 0 to 10 psig	0	A – 10 / 50 SCCM <sup>3</sup>	C – High flow manifold (300 SLPM fill rate)
	C – 0 to 15 psig	0	B – 100 / 250 SCCM <sup>3</sup>	
	D – 0 to 30 psig	0	C – 1000 / 3000 SCCM <sup>3</sup>	
	E – 0 to 50 psig	0	D – 10 SLPM	
	F – -15 to 95 psig	0	E – 30 S1LPM	
	G – -15 to 0 psig	0		
	H – -5 to 0 psig	0		
	I – -15 to +15 psig	0		

<sup>3</sup>The A, B and C are dual range flow meters, e.g., A can be configured to operate as either a 10 SCCM or 50 SCCM Full Scale flow meter. Selection is performed remotely by the controller software.



# Standard Accessories

## Included with every 3520 Series system



Part number	Description	
10500-3520-AC01	24 VDC power supply for 3520 Series Leak Tester Module, universal input 120/240 VAC, NA power cord. (Not NEMA-rated.)	
10500-3520-ENET	Ethernet Cable – M12 4 pin D-code straight shielded plug to RJ45 connection, 5 m long	
10500-3520-PCON	Power connector, M12 T-code 4 pin socket, field wireable unshielded	
10500-3520-ECON	Ethernet connector, M12 D-code 4 pin plug, field wireable, shielded	
10500-3520-VIBM	Vibration mount kit	
10500-3520-TL00	Latching valve service tool (shipped only with “B” fill configurations)	

# Optional Accessories

## Temperature sensors





Part number	Description	
10500-3520-RT DA	Air temperature RTD, Platinum, Class A, 100 Ohm, 6 inch, M12 A-code plug, 1/4 NPT connection, wire code 1	
10500-3520-RTDP	3520 Cu tipped part temperature RTD, Platinum, Class A, 100 Ohm, 6 inch, M12 A-code plug, 1/4 NPT connection, wire code 1	
10500-3520-RTDC	3520 RTD cable – M12 4 pin A-code straight plug to M12 4 pin A-code straight socket, non-shielded, 5 m long	

## Electrical accessories





Part number	Description	
10500-3520-ENE2	Ethernet Cable – M12 4 pin D-code straight shielded plug to RJ45 connection, 10 m long	
10500-1200-ETH1	Gigabit Switch 5 Port 10/100/1000 Wide Temp	



## Pneumatic accessories

Part number	Description	
10500-3520-CL00	Metal orifice custom flow standard with Swagelok QC4 connection. Specify test pressure (vacuum to 90 psi) and leak rate in SCCM (e.g., 5 SCCM at 15 psig)	
10500-3520-CL01	Metal orifice custom flow standard with Staubli RBE 03 connection. Specify test pressure (vacuum to 90 psi) and leak rate in sccm (e.g., 5 sccm at 15 psig)	
10500-3520-FT00	Calibration port quick connect, SS Swagelok QC4 body 1/4 NPT MALE	
10500-3520-FT01	Calibration port quick connect, SS Staubli RBE 1/4 NPT Male IA / W	
10500-3520-PREG	Precision pre-regulator for 3520 Series systems with mounting bracket. 1/2 NPT ports, max 500 psig in, 2-150 psig out, 40 SCFM, 0.1% supply pressure effect	

## Multiplexer

Part number	Description	
10500-3520-MB32	2-position, 3/2 way latching valve multiplexer for use with a 3520 Series B model. 50 psi maximum operating pressure; includes 3m cable.	
10500-3520-MC31	3/2 way external leak test valve for use with a 3520 Series C model. Includes 3m cable.	
10500-3520-MC32	Multiplexer valve assembly for 3520 Series C Model: 2 station leak test manifold with 3/2 way valves; includes 3m cable.	
10500-3520-MC34	Multiplexer valve assembly for 3520 Series C Model: 4 station leak test manifold with 3/2 way valves; includes 3m cable.	
10500-3520-MPXR	Multiplexer valve assembly for 3520: 4 station leak test manifold NC valves, 24 V, 2.5 W each valve. Includes 4 NO to NC conversion kit and 3m cable.	

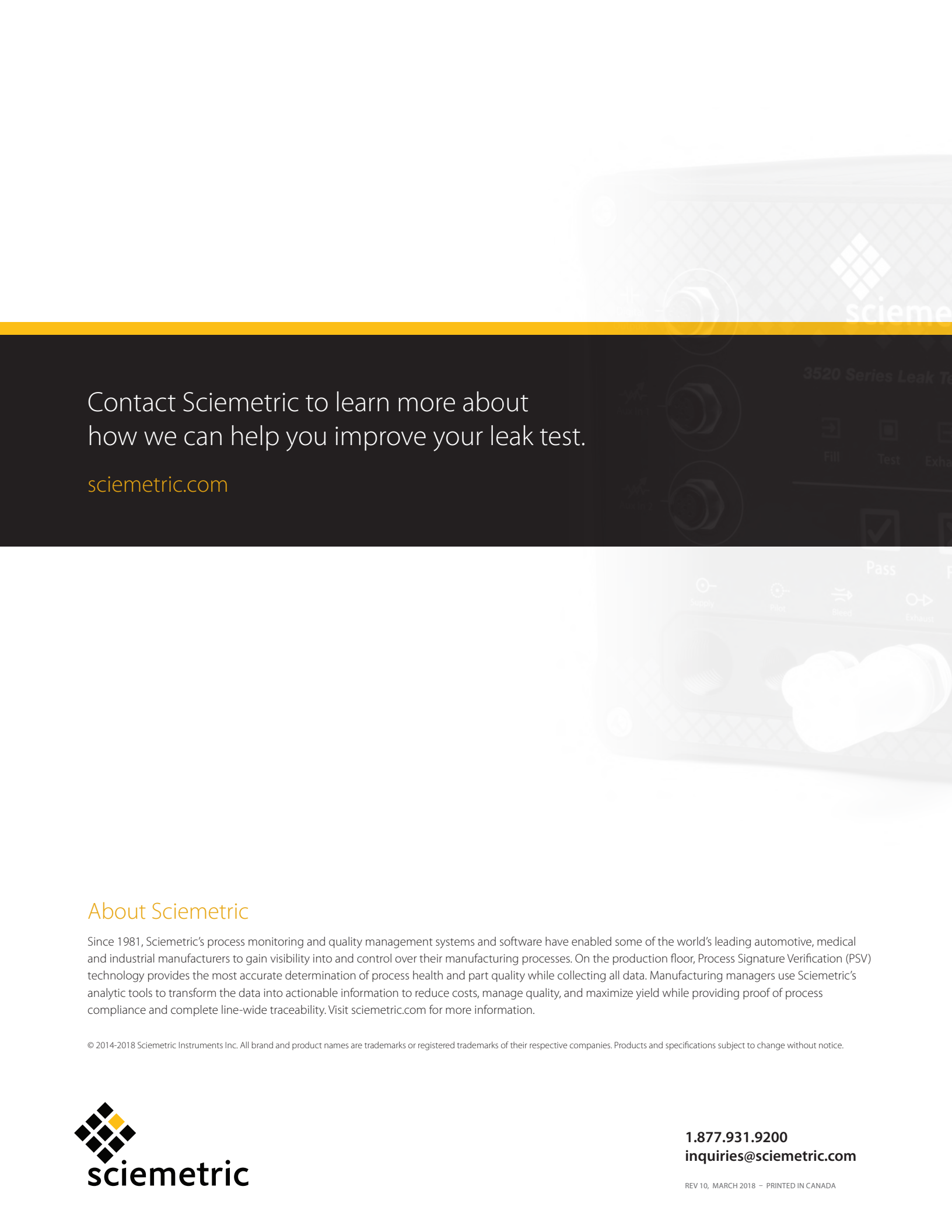

Contact Sciometric to learn more about  
how we can help you improve your leak test.

[sciometric.com](http://sciometric.com)

## About Sciometric

Since 1981, Sciometric's process monitoring and quality management systems and software have enabled some of the world's leading automotive, medical and industrial manufacturers to gain visibility into and control over their manufacturing processes. On the production floor, Process Signature Verification (PSV) technology provides the most accurate determination of process health and part quality while collecting all data. Manufacturing managers use Sciometric's analytic tools to transform the data into actionable information to reduce costs, manage quality, and maximize yield while providing proof of process compliance and complete line-wide traceability. Visit [sciometric.com](http://sciometric.com) for more information.

© 2014-2018 Sciometric Instruments Inc. All brand and product names are trademarks or registered trademarks of their respective companies. Products and specifications subject to change without notice.



**1.877.931.9200**  
**[inquiries@sciometric.com](mailto:inquiries@sciometric.com)**

REV 10, MARCH 2018 - PRINTED IN CANADA